



KANSAS WOOD BURNING FIREPIT

Assembly Instructions

PLU-146108

WARNING

PLEASE READ THESE INSTRUCTIONS CAREFULLY BEFORE ASSEMBLY AND USE. FAILURE TO FOLLOW THESE INSTRUCTIONS COULD RESULT IN SERIOUS INJURY OR DAMAGE TO YOUR HOME AND/ OR GARDEN.

READ AND FOLLOW ALL INSTRUCTIONS.

RETAIN THESE INSTRUCTIONS FOR FUTURE REFERENCE.

- For Outdoor Use Only. DO NOT use indoors. Place in a well-ventilated area.
- DO NOT use gasoline, kerosene alcohol or any other explosive fuel.
- DO NOT touch metal parts of firepit until it has completely cooled to avoid burns.
- DO NOT use the firepit unless it is completely assembled and all parts are securely fastened and tightened.
- This item should be positioned and used away from combustible objects such as a sheds, wooden & composite decking, fences, furniture, trees & shrubs.
- NEVER leave firepit unattended when lit.
- ATTENTION! This firepit will become very hot, do not attempt to move it during operation.
- WARNING! DO NOT wear loose clothing around a firepit whilst in use or hot.
- WARNING! Keep children and pets away!
- NEVER take out the logs grid whilst in use.
- Always place the firepit on a level surface and far away from combustible materials.
- This is not a tabletop firepit. DO NOT place the firepit on any tabletop.
- DO NOT move the firepit once the firepit is lit.
- DO NOT use the firepit in adverse weather conditions especially high winds.
- NEVER dismantle this appliance whilst in use or hot.
- DO NOT use, or leave out, in adverse weather conditions (including wind and rain), or during the winter months.





SELECTING LOCATION



WARNING

- DO NOT use firepit indoors.
- Only use this item on a firm, stable, non-combustible surface such as a patio area.
- This firepit is for outdoor use only and should be placed on a firm, level surface. The firepit should be located in an open area with good ventilation, use in unventilated areas can endanger your life.
- DO NOT use this firepit in a fully or partially enclosed area such as a garage, breeze way, carport, porch or under a surface that can catch fire.
- Always make sure the firepit is fully extinguished and completely cool before applying any covers (not included) OR storing away, remember logs can remain hot for sometime and could reignite under certain conditions.
- CAUTION! NEVER STORE a firepit indoors unless ALL logs and ash have been thoroughly removed and thrown away outdoors, and all firepit surfaces have been cleaned and are cool, as otherwise this could lead to fire/and or emissions of poisonous gases that could cause death.
- CAUTION! Do not use spirit or petrol for lighting or re-lighting! Use only fire lighters complying to EN1860-3!
- DO NOT use to cook food.
- Pouring flammable liquids into embers will cause spurts of flames or explosions.
- DO NOT add logs soaked in lighter fluid to the fire.
- DO NOT use this product near heat sensitive or combustible structures such as vinyl, composite or wood decking.
- Combustible or flammable material should NEVER be stored or used within 36 inches of your firepit
- Try to keep firepit in a permanent position (when not being stored). Moving it about could crack the firepit.
- DO NOT use on grass or artificial grass.

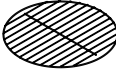
PARTS LIST

Please check parts against the list below before assembling firepit. Take a few moments to familiarise yourself with the contents. Check that all holes are clear of paint before assembly.

A	Lid		1
B	BBQ net		1
C	Grate		1
D	Fire bowl		1

E	Main body		1
F	Screw and nut M6		3
G	Safety fork		1

ASSEMBLY



WARNING

While every effort has been made in the manufacture of your burner to remove any sharp edges, you should handle all components with care to avoid accidental injury.



Tools required: Either a Philips crosshead or flat-bladed screwdriver and either an adjustable wrench or a pair of pliers.

Now your firepit is ready for use.

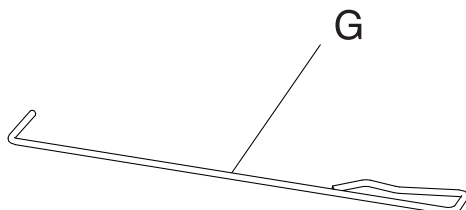
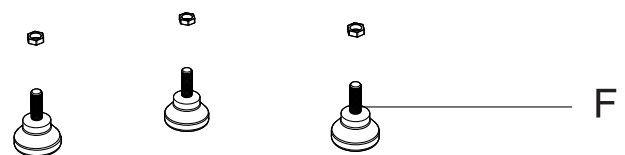
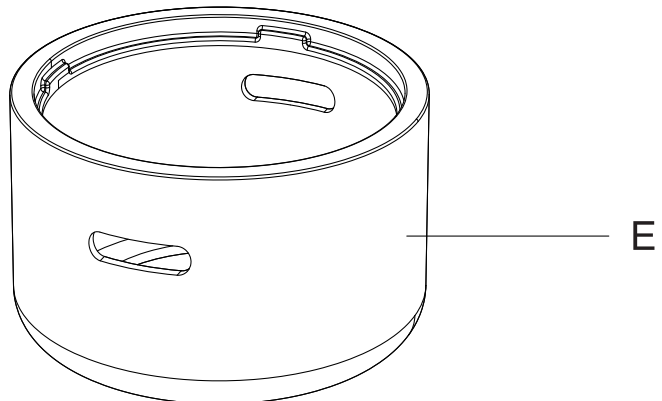
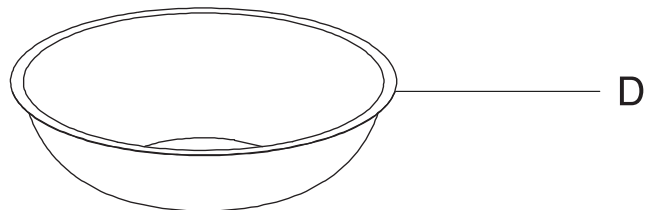
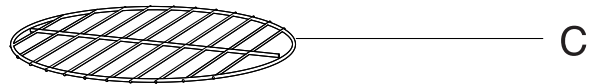
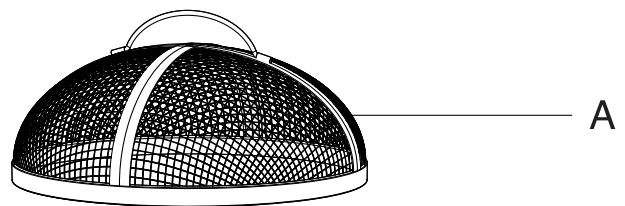

INSTRUCTIONS FOR USE

1. Make sure the assembly instructions have been followed correctly.
2. Set the firepit up in a suitable position, on a level surface away from areas likely to catch fire.
The base of the firepit will get hot so ensure it stands on a suitable surface.
3. Using logs with a suitable lighting method:

Method 1 - Lighting Fluid/Gel

- a) Set up your firepit in a safe place. Place small pieces of wood logs in the fire bowl to a depth of 3-5 cm.
- b) Taking care not to spill any liquid onto your hands or clothes. Squirt the lighting fluid over the logs.
- c) Wait for 30 seconds to allow the liquid to soak into the logs.
- d) Do not light the logs if you spill fluid onto your clothes.
- e) Light the logs using a long taper or safety lighter.
- f) The logs will then burn for a period of time with flames. After fire is started larger pieces of wood logs can be added.
- g) DO NOT squirt liquid onto burning logs.

Method 2 - Lighting Blocks

- a) Place three or four Lighting Blocks in the centre of the firepit fire bowl and light with long taper or safety lighter.
- b) Carefully place pieces of logs around each burning block. Add more logs as required, in a pyramid formation.
- c) When burning is established, spread the fuel out evenly using the poker provided.

4. Make sure that the log grate is inserted into correct position using the safety fork provided.
5. ALWAYS WEAR OVEN GLOVES WHEN HANDLING.
6. When you have finished with the firepit never pour cold water directly on the logs to extinguish them as this may damage the appliance. Use old cinders, sand or fine water spray.
7. DO NOT add a large amount of wood logs at one time.
8. Keep the fire reasonable. A large fire can damage or shorten the life of the unit.
9. Be sure fire is out before leaving the unit unattended



FIREPIT SAFETY HINTS

1. Stand your firepit on a safe, level surface, away from flammable items such as wooden fences or over-hanging tree branches. NEVER USE your firepit indoors or in confined areas.
2. DO NOT use petrol, paraffin, methylated spirit or lighter fuel to light your basket. Special lighting fluid, pastes and fire lighters are available.
3. Once lit DO NOT move your firepit or leave it unattended.
4. Keep children and pets a safe distance from the firepit.
5. Keep a fire extinguisher or fire blanket handy.
6. During use the firepit will become hot, so only handle lids etc with an oven glove.
7. Ensure that the firepit has completely cooled before removing the ash.

CAUTION













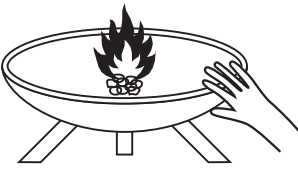

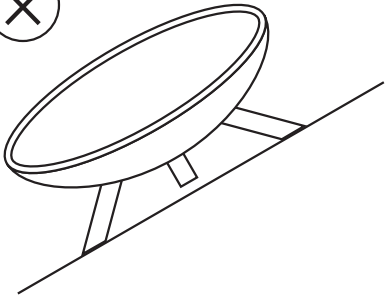

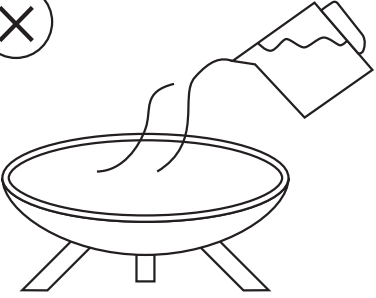

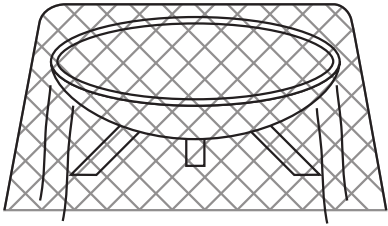

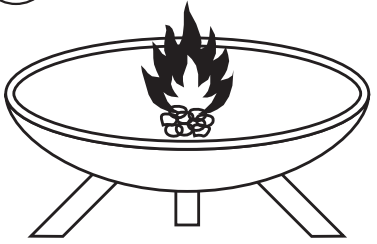

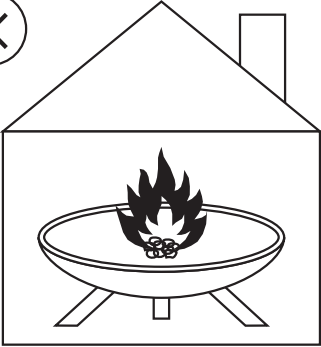
Firepit will remain very hot for a long time after it is used. Make sure firepit has cooled before moving.
Use care when working near fire, shirt sleeves can catch fire easily.

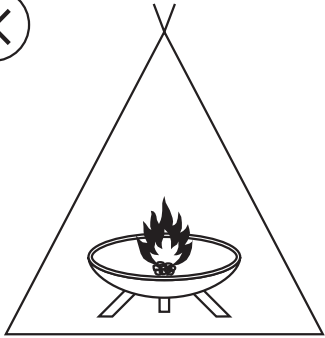

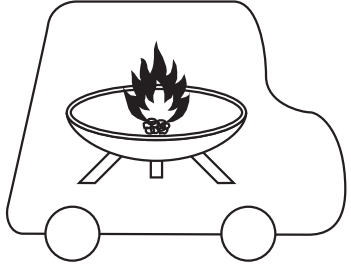
WARNING

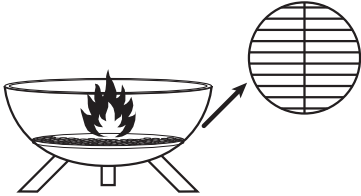

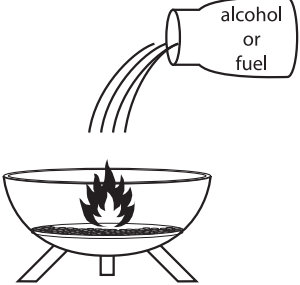
- Dispose of all polythene packing carefully and keep out of the reach of children.
- Please read the section on firepit safety prior to using your firepit.
- Please read all instructions carefully and keep outer packaging to refer to photograph of finished product in case of difficulty.

  <p>KEEP FIRE UNDER CONTROL</p>	  <p>DO NOT TOUCH HOT!</p>	  <p>USE ON A FLAT EVEN SURFACE</p>
  <p>DO NOT EXTINGUISH WITH WATER</p>	  <p>COVER UP WHEN NOT IN USE</p>	  <p>USE SMALL LOGS</p>
  <p>NEVER USE INDOORS</p>	  <p>NEVER USE IN TENTS</p>	  <p>NEVER USE IN VEHICLES</p>
  <p>ALWAYS PLACE FIREWOOD ON TOP OF GRID BEFORE BURNING</p>	  <p>ONLY USE RECOMMENDED FIRE LIGHTERS WITH THIS PRODUCT. DO NOT USE ALCOHOL OR OTHER FUELS</p>	  <p>DO NOT TOUCH OR MOVE THIS ITEM WHILST IN USE OR STILL HOT. RISK OF INJURY.</p>

PLEASE RETAIN THE INSTRUCTION MANUAL FOR FUTURE USE

OGALAS ULC
D12 ECR9
MADE IN CHINA

